

FOGU

2023

GIRARROSTI



GIRARROSTO ELETTRICO 220 VOLT

EAN 8032632267409

COD. ART. GIELCS

IMB 2 PZ

NOTE ELETTRICO CON SPINA

SPIEDI NON INCLUSI

GIRARROSTO A BATTERIA 4.5 VOLT

EAN 8032632267416

COD. ART. GIBACS

IMB 2 PZ

NOTE Utilizzabile con pila 4,5 V tipo R12



SPIEDI NON INCLUSI

GIRARROSTI



GIRARROSTO MONOMOTORE ELETTRICO/BATTERIA

EAN	8032632267430
COD. ART.	GIMOC
IMB	2 PZ
NOTE	Utilizzabile sia con batteria da 4.5 V a 12 V sia con spina elettrica

SPIEDI NON INCLUSI

GIRARROSTO DOPPIO ELETTRICO/BATTERIA

EAN	8032632267423
COD. ART.	GIDOBALCS
IMB	1 PZ
NOTE	Composto da 1 Girarrosto Elettrico e 1 Batteria



SPIEDI NON INCLUSI

GIRARROSTI

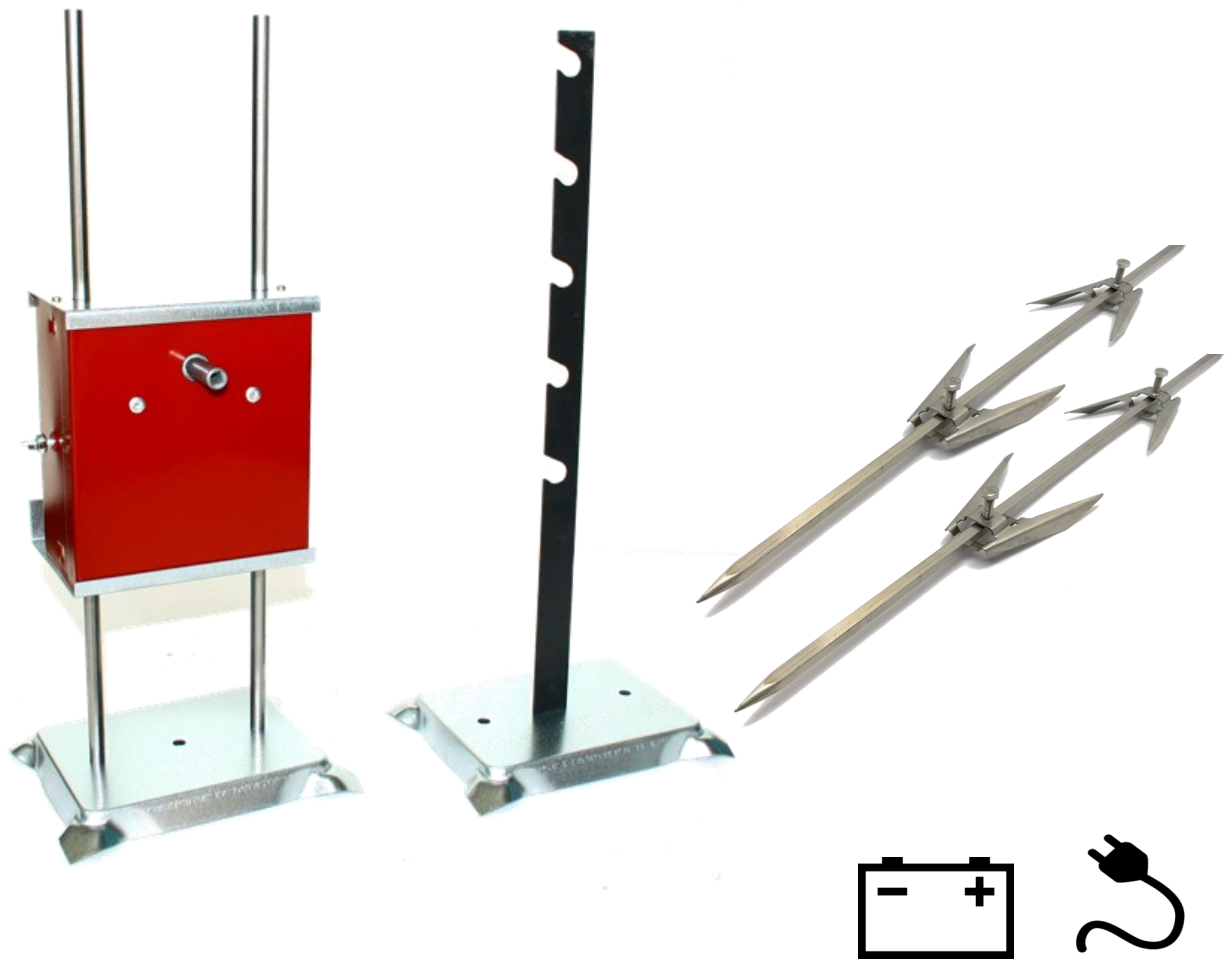

GIRARROSTO KIT 2 SPIEDI + FORCHETTINE

MODELLO	ELETTRICO	MONOMOTORE ELETTRICO/BATTERIA
EAN	8050030091020	8050030091037
COD. ART.	SKITGE	SKITGB
IMB	1 PZ	1 PZ
NOTE	Funzionamento a corrente 220Volt dotato di spiedi e forchette in acciaio inox ad uso alimentare	Funzionamento a batteria 4.5volt tipo R12 dotato di spiedi e forchette in acciaio inox ad uso alimentare

GIRARROSTI

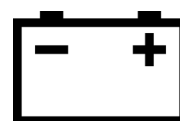
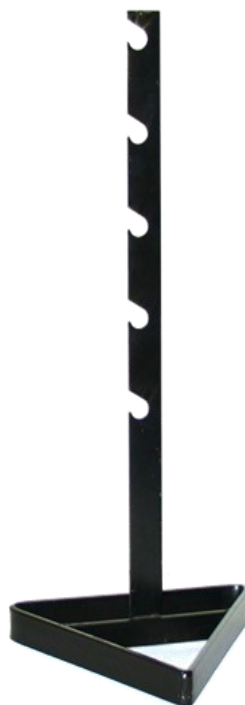

SPIEDO NON INCLUSO

GIRARROSTO MAXI

MODELLO	ELETTRICO	MONOMOTORE ELETTRICO/BATTERIA
EAN	8054247083755	8054247087814
COD. ART.	S1032	S1033
IMB	1 PZ	1 PZ
NOTE	Girarrosto adatto per cuocere selvaggina di grossa taglia	Girarrosto adatto per cuocere selvaggina di grossa taglia. Funziona con una batteria di automobile o con trasformatore 220 volt (trasformatore incluso)

SPIEDI E ACCESSORI

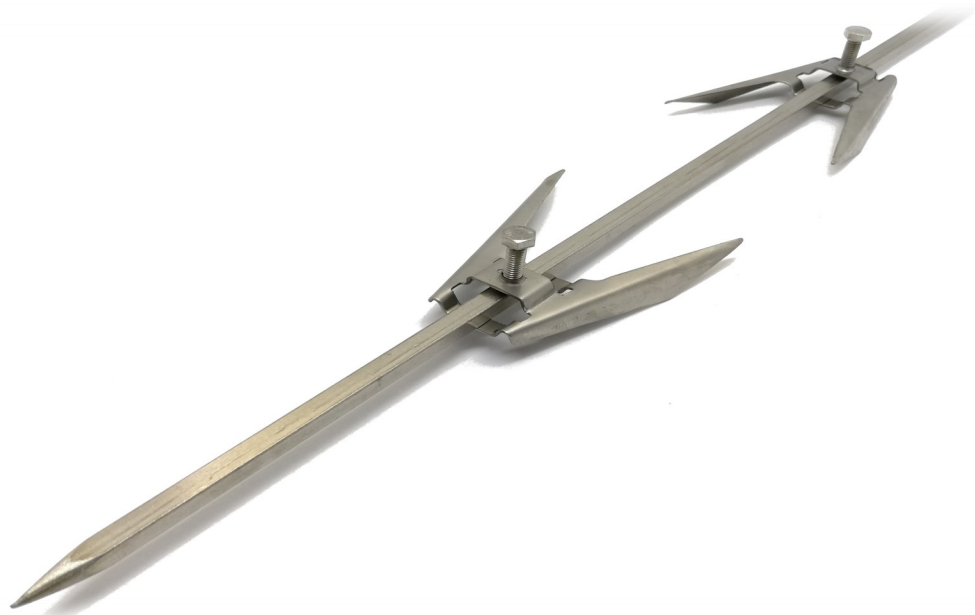

KIT SPIEDO QUADR CM 100 + 2 FORCHETTINE

EAN	8051513126154
COD. ART.	SKIT
IMB	4 PZ
NOTE	CM 100 ACCIAIO INOX AISI 304 USO ALIMENTARE



	FORCHETTINE INOX FERMACARNE 2 PZ	FORCHETTA INOX FERMACARNE MAXI
EAN	8032632267553	8054247086091
COD. ART.	S1513B	S1512
IMB	10 PZ	5 PZ
MISURA	cm 8x6	cm 18 x cm 8.5

SPIEDI E ACCESSORI

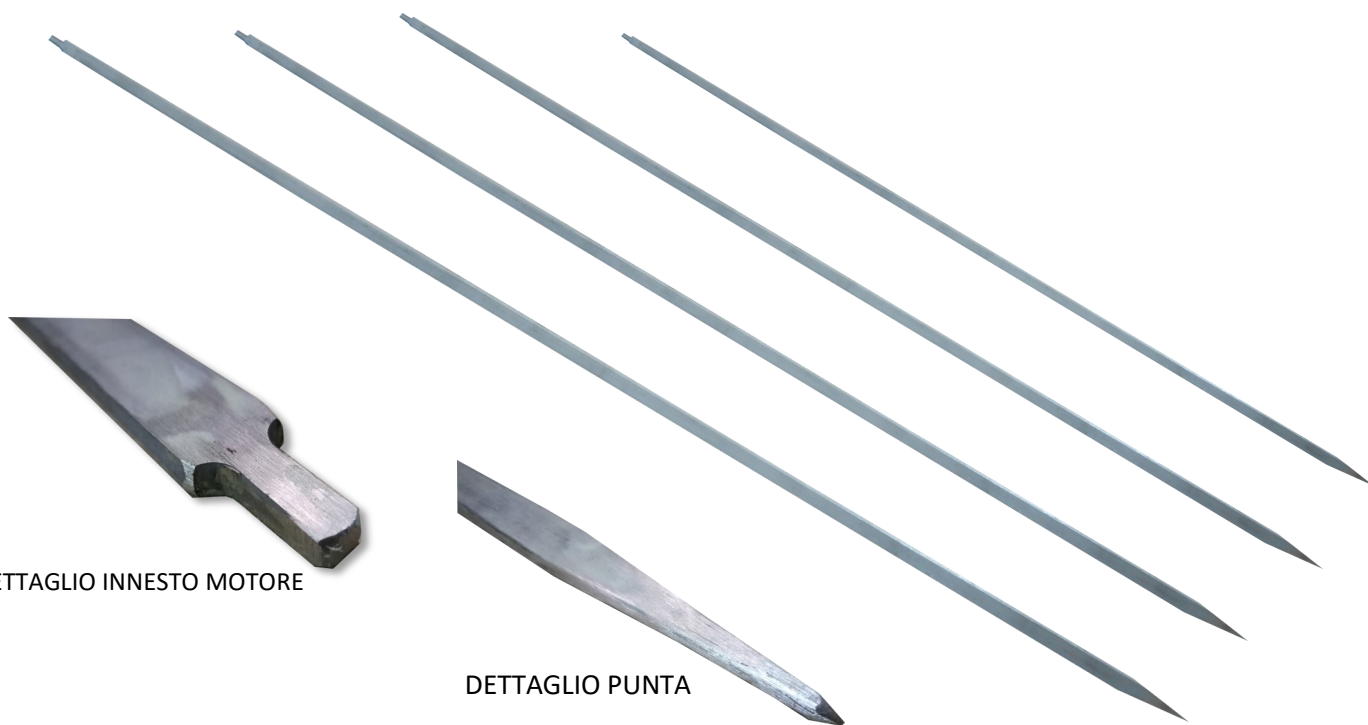

DETTAGLIO INNESTO MOTORE

DETTAGLIO PUNTA

	SPIEDO INOX PER GIRARROSTO		SPIEDO INOX PER GIRARROSTO MAXI	
EAN	8054247083779	8054247083786	8054247085438	8050030090863
COD. ART.	S2001	S2002	S2032	S2033
IMB	4 PZ	4 PZ	2 PZ	2 PZ
NOTE	Acciaio inox aisi 304 uso alimentare	Acciaio inox aisi 304 uso alimentare	Acciaio inox aisi 304 uso alimentare	Acciaio inox aisi 304 uso alimentare
MISURA	80 CM	100 CM	100 CM	130 CM



ARROSTICASTAGNE PER GIRARROSTO	
EAN	8032632267508
COD. ART.	S1570
IMB	2 PZ
NOTE	Cm 26 x diam 16 c/asta cm 80

RICAMBI GIRARROSTO

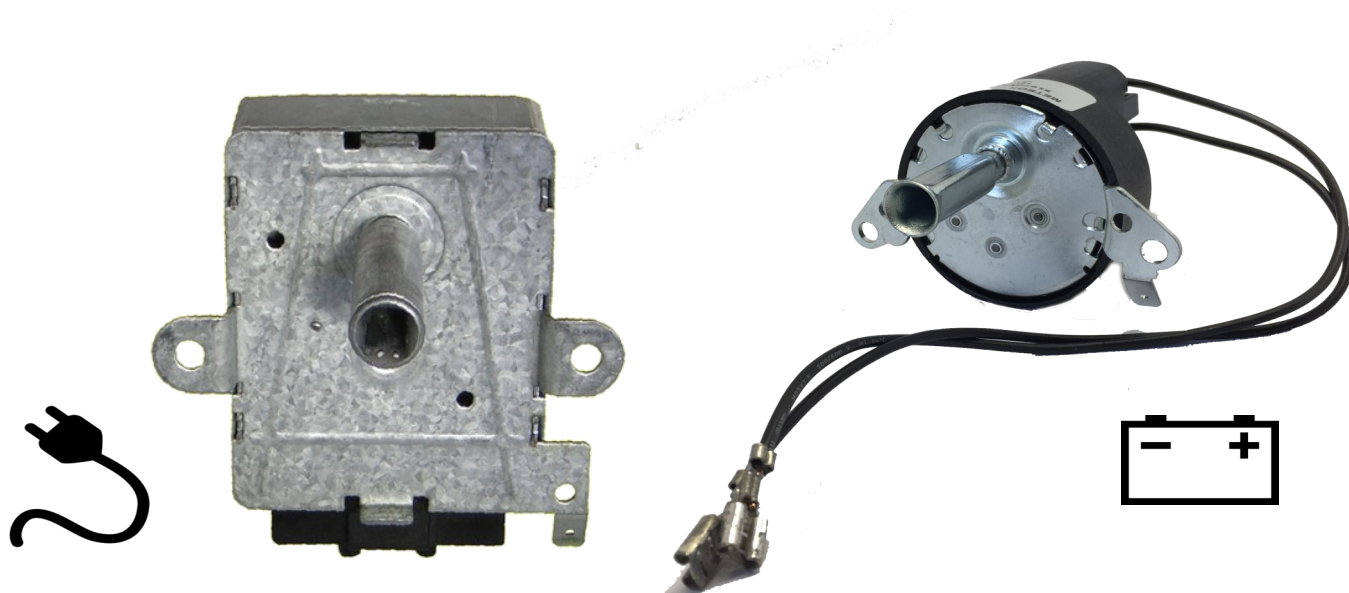

MOTORIDUTTORE		
EAN	8054247087852	8054247087869
COD. ART.	S1522	S1521
IMB	PZ 5	PZ 5
NOTE	Potenza 5 Watt	Coppia max 100 N.cm
MODELLO	ELETTRICO 220V	BATTERIA 4,5V

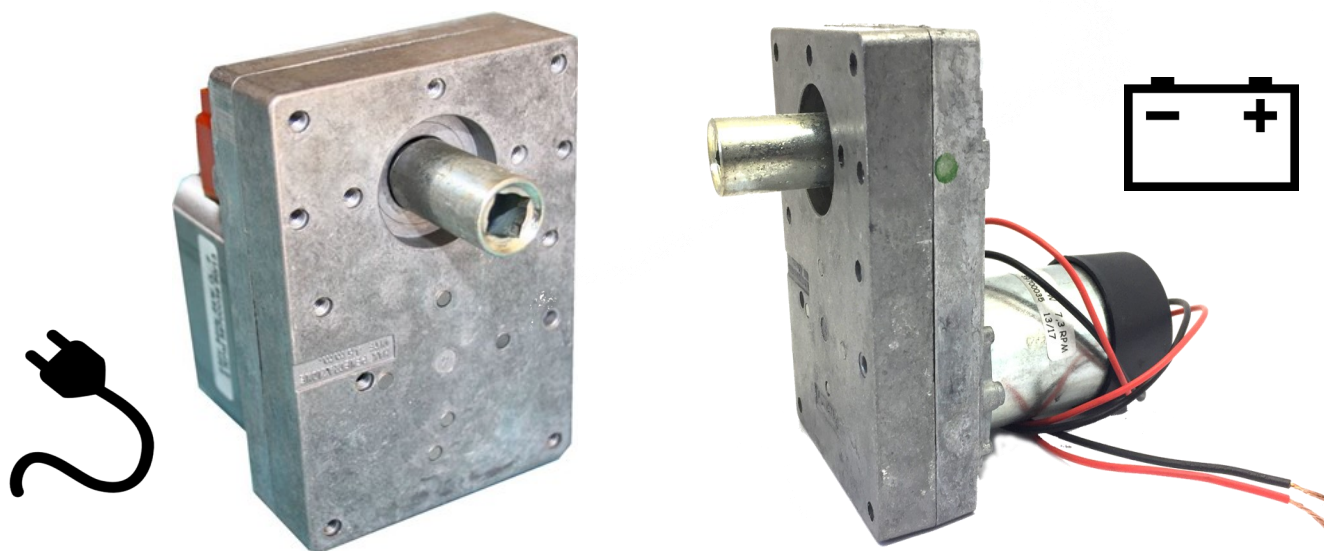

MOTORIDUTTORE MAXI		
EAN	8054247087876	8054247087883
COD. ART.	S1527	S1525
IMB	PZ 2	PZ 2
NOTE	Potenza nominale 26 watt	Potenza nominale 22 Watt
MODELLO	ELETTRICO 220V	BATTERIA 12/24V

RICAMBI GIRARROSTO

TRASFORMATORE PER GIRARROSTO MONOMOTORE

EAN	8054247087890
COD. ART.	S1545
IMB	PZ 4
NOTE	4.5 Volt 1 Ampere



TRASFORMATORE PER GIRARROSTO MONOMOTORE MAXI

EAN	8054247087906
COD. ART.	S1545M
IMB	PZ 4
NOTE	15 Volt 2 Ampere



RICAMBI GIRARROSTO E RICARICHE GAS



	ASOLA PORTASPIEDO	COPPIA ASTINE PER	BASE ZINCATA
EAN	8051513123283	8051513123290	8051513123306
COD. ART.	S1502	S1501	S1505
IMB	1	2	1



RICARICA FORNELLINO

EAN	5903240385140	5903240385003
COD. ART.	RIFO3	RIFO1
IMB	48	28
NOTE	Cartuccia GAS 190gr PROPAN BUTANO	Cartuccia GAS Butano 400 ml Certificata Dekra in accordo alla legge EN147 efficienza 3h a 20°
MODELLO	190 GR	227 GR

ACCESSORI CAMINO



	PALETTA CAMINO	PALETTONE CAMINO
EAN	8032632267447	8032632267454
COD. ART.	S4502	S4503
IMB	12 PZ	12 PZ
MISURA	cm 45 x 10	cm 45 X 20 Peso gr 420

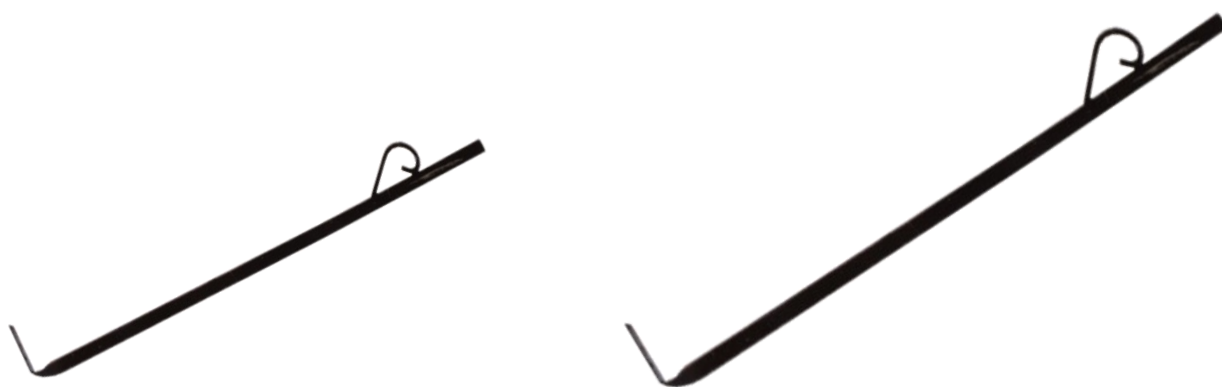

SOFFIETTO CON PIEGA E MANICO		
EAN	8054247085667	8032632267485
COD. ART.	S4508	S4506
IMB	12 PZ	12 PZ
MISURA	cm 55	cm 80

ACCESSORI CAMINO



	SCOPINO CAMINO	
EAN	8050030096414	8050030096377
COD. ART.	FE6414	FE6377
IMB	12 PZ	12 PZ
MODELLO	ACCIAIO / OTTONE	PLASTICA

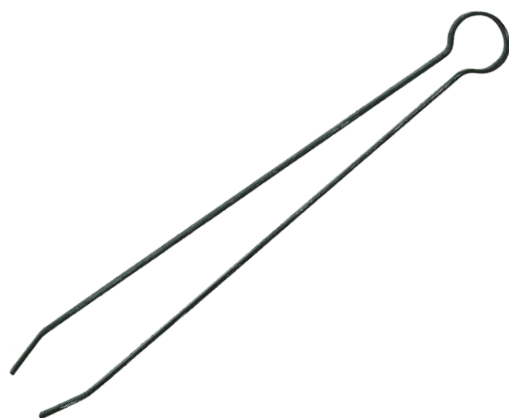

	PINZA CAMINO	ATTIZZATORE CON MANICO IN LEGNO
EAN	8054247083854	8050030096384
COD. ART.	S4504	FE6384
IMB	12 PZ	12 PZ

ACCESSORI CAMINO



	SOFFIATORE A ROTAZIONE ECO	SOFFIATORE MANTICE LUX
EAN	8051513124204	8051513124211
COD. ART.	SSOF	SSOFX
IMB	12 PZ	4 PZ



	ACCENDICARBONELLA	SCOPETTA SAGGINA	SPAZZOLA PULISCI GRIGLIA
EAN	8050030090511	8054247086442	8054247086992
COD. ART.	ABBQ	SCOSA	SPAZ
IMB	6 PZ	20 PZ	12 PZ
NOTE	MISURE h 28 x ø 17		

ACCESSORI CAMINO



SERVIZIO CAMINETTO MEDIO COMPLETO

EAN 8054247083885

COD. ART. S4512

IMB 2 PZ

NOTE Altezza cm 55



SERVIZIO CAMINETTO ECO

EAN 8054247089641

COD. ART. S4512EC

IMB 5 PZ



ACCESSORI CAMINO



CESTELLO BRUCIALEGNA FERRO ECO

EAN 8050030096407

COD. ART. FE6407

IMB 2 PZ

CESTELLO BRUCIALEGNA ANGOLO

EAN 8050030069391

COD. ART. FE6391

IMB 2 PZ



CESTELLO BRUCIALEGNA PESANTE CM 43x29

EAN 8054247083908

COD. ART. S4565

IMB 2 PZ

NOTE Misure cm 43x30x h 20 Peso Kg 6,3

ACCESSORI CAMINO

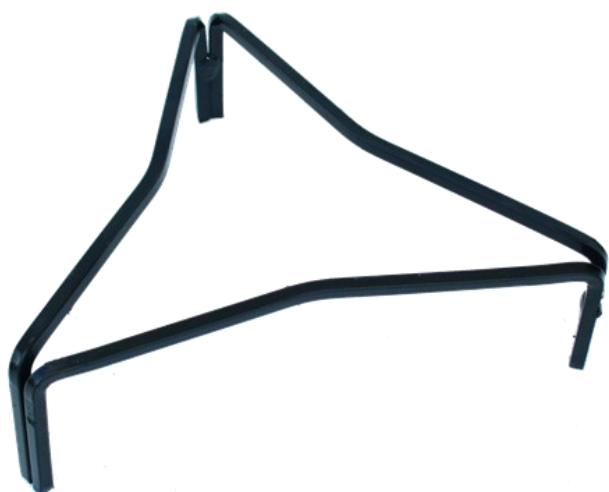

TRIANGOLO IN FERRO

EAN	8032632267492
COD. ART.	S4551
IMB	4 PZ
MISURE	CM 22x 20 x h 7

TREPIEDE TONDO

EAN	8054247083939	8054247083946
COD. ART.	S4542	S4543
IMB	4 PZ	4 PZ
MISURE	Diametro cm 18	Diametro cm 22



ALARE PESANTE CM 32

EAN	8054247083892
COD. ART.	S4559
IMB	2 PZ
MISURE	Lunghezza ~ cm 32 x h 32

ACCESSORI CAMINO

ALARE CON ANELLO	
EAN	8050030096353
COD. ART.	FE6353
IMB	2

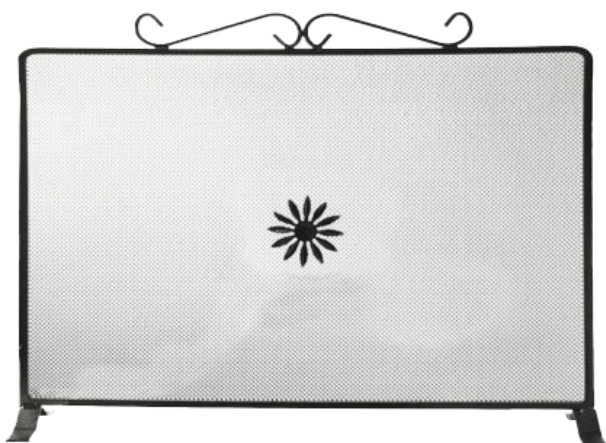
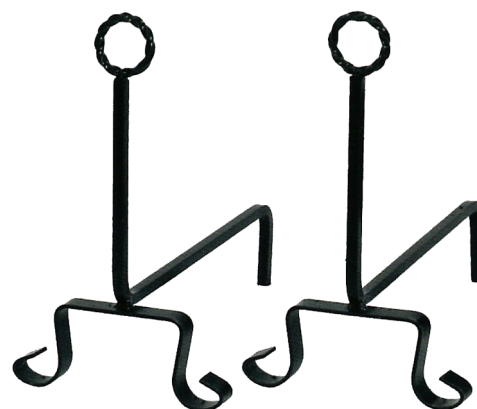

PARASCINTILLE 1 ANTA	
EAN	8054247083960
COD. ART.	FE6360
IMB	6 PZ
MISURE	Misure cm 50x50 Peso Kg 2,1

PARASCINTILLE 3 ANTE	
EAN	8054247083977
COD. ART.	FE8494
IMB	2 PZ
MISURE	Misure cm 93x50 Peso kg 4.5



PADELLE CASTAGNE



PADELLA CASTAGNE MANICO LEGNO

EAN	8054247086039	8054247089658
COD. ART.	PACALE	PACALE30
IMB	PZ 24	PZ 24
MISURE	DIAMETRO 26	DIAMETRO CM 30



PADELLA CASTAGNE MANICO FERRO

EAN	8054247086046	8051513121852
COD. ART.	PACAFE	PACAFE30
IMB	PZ 24	PZ 24
MISURE	DIAMETRO CM 26	DIAMETRO CM 30

PALE PIZZA E IMBUTO FRITTURA



PALA PIZZA		
EAN	8054247083793	8054247083809
COD. ART.	S5070	S5071
IMB	5 PZ	5 PZ
NOTE	Dimensioni pala escluso manico cm 33 x 28	Dimensioni pala escluso manico diametro cm 28



IMBUTO ALLUMINIO PER FRITTURA

EAN	8054247085308
COD. ART.	S5021
IMB	12 PZ

TEGLIE

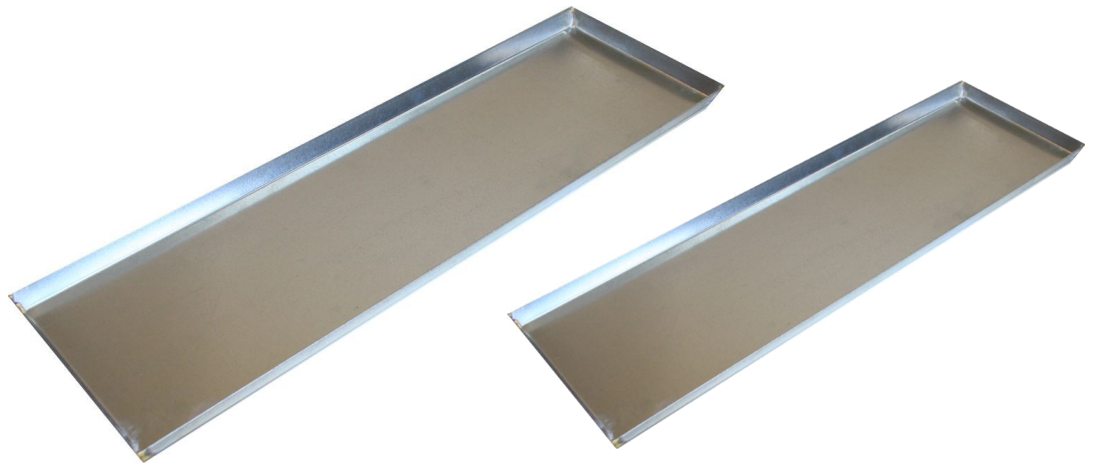

TEGLIA SOTTOGIRARROSTO FERRO

EAN	8054247083731	8032632267546
COD. ART.	S6517	S6516
IMB	2 PZ	4 PZ
NOTE	CM 100X30	CM 66X20



TEGLIA BANDA STAGNATA

EAN	8054247084011	8054247083991	8054247084004	8054247083984	8054247087401
COD. ART.	S6504	S6502	S6503	S6501	S6521
IMB	10 PZ	14 PZ	10 PZ	16 PZ	10 PZ
NOTE	cm 40x38	cm 40x28	cm 37x35	cm 36x27	cm 34x14

TRIS FORMINE PER DOLCI



cm 5.5x3xh1.7

cm 6.8x3.7xh1.7

cm 8.5x4.4xh1.7

SET 3 PZ FORMINE SARDEGNA

EAN	8051513128530
COD. ART.	SFOSA
IMB	12
NOTE	Blister 3 pz lamiera banda stagnata



SET 3 PZ FORMINE TONDE

SET 3 PZ FORMINE STELLA

EAN	8050030096346	8050030096339
COD. ART.	SFOTO	SFOSTE
IMB	12	12
NOTE	Blister 3 pz lamiera banda stagnata cm 6.5 - 5.5 - 5	Blister 3 pz lamiera banda stagnata cm 7 - 6 - 4

FORMINE PER DOLCI



	SET 6 PZ FORMINA TAGLIAPASTA FIORE 5 PUNTE	SET 6 PZ FORMINA TAGLIAPASTA FIORE 6 PUNTE
EAN	8054247084288	8054247084295
COD. ART.	S6018	S6019
IMB	12 SET	12 SET
NOTE	Banda stagnata diametro cm 8	Banda stagnata diametro cm 6



	SET 6 PZ FORMINA TAGLIAPASTA BISCOTTO cm 10x3	SET 6 PZ FORMINA TAGLIAPASTA CIAMBELLA PICCOLA
EAN	8054247085377	8054247085568
COD. ART.	S6011	S6012
IMB	12 SET	12 SET
NOTE	Banda stagnata cm 10x3	Banda stagnata cm 5

FORMINE PER DOLCI



	SET 6 PZ FORMINE TAGLIAPASTA ASSORTITE
EAN	8054247085018
COD. ART.	S6005
IMB	12 SET
NOTE	assortiti dimensioni circa 10 cm ciascuno



	FORMINA TAGLIAPASTA SEBADAS MEDIA	FORMINA TAGLIAPASTA SEBADAS GRANDE
EAN	8054247085254	8054247085261
COD. ART.	S6053	S6054
IMB	12 PZ	12 PZ
NOTE	Diametro cm 12	Diametro cm 13.5

GRATICOLE

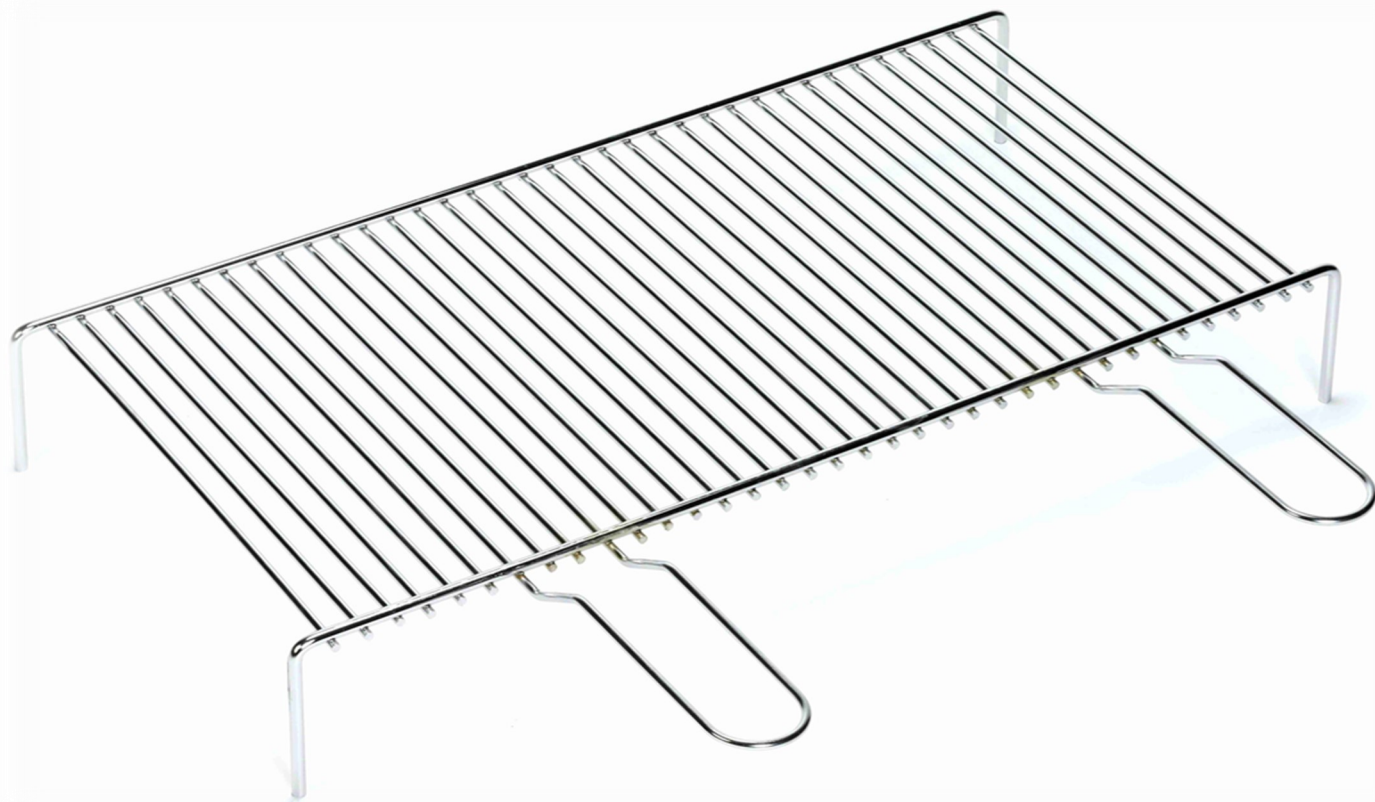

GRATICOLA PESANTE CROMATA SINGOLA CON PIEDI

EAN	8054247085810	8054247085827	8054247085834
COD. ART.	GRACA25F	GRACA30F	GRACA40F
IMB	5 PZ	5 PZ	5 PZ
MISURA	Cm 30 X 25	Cm 30 X 30	Cm 35 X 40
EAN	8054247085841	8054247085858	8054247085865
COD. ART.	GRACA50F	GRACA60F	GRACA70F
IMB	5 PZ	5 PZ	5 PZ
MISURA	Cm 35 X 50	Cm 35 X 60	Cm 35 X 70

GRATICOLE

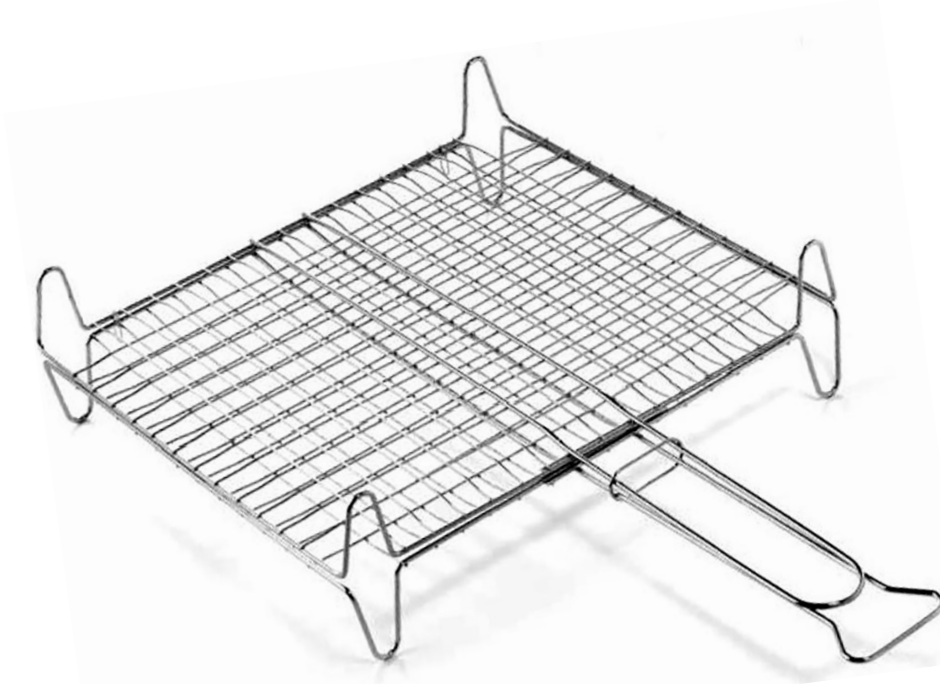

GRATICOLA INCROCIATA BOMBATA CON PIEDI

EAN	8054247085896	8054247085773	8054247085780	8054247085797	8054247085803
COD. ART.	GRABO20F	GRABO27F	GRABO37F	GRABO40F	GRABO45F
IMB	5 PZ	5 PZ	5 PZ	5 PZ	5 PZ
NOTE	Cm 22 X 22	Cm 27 X 27	Cm 27 X 37	Cm 35 X 40	Cm 40 X 45

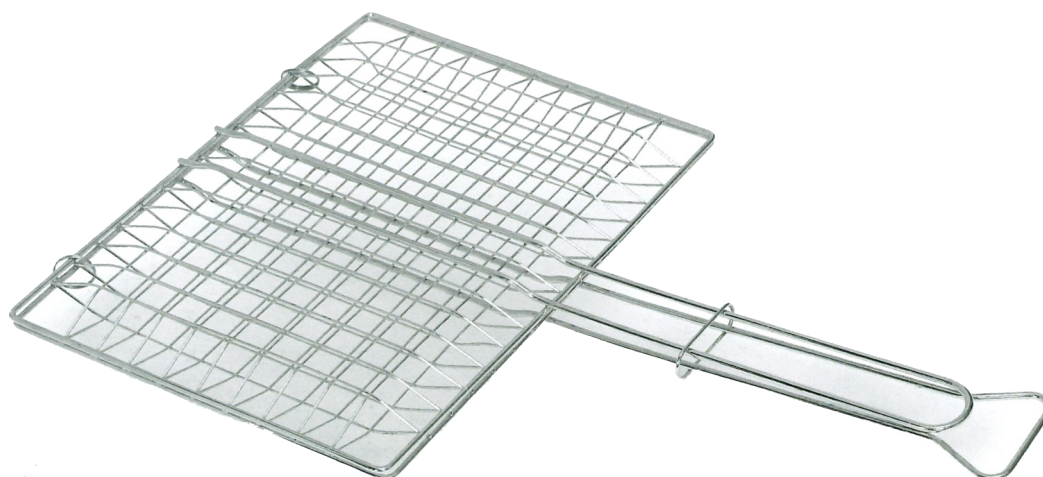

GRATICOLA INCROCIATA BOMBATA SENZA PIEDI

EAN	8054247081577	8054247081584
COD. ART.	GRABO37	GRABO40
IMB	5 PZ	5 PZ
MISURA	27 X 37	35 X 40

BALCONIERE



BALCONIERA FISSA p 22 x h 16 cm

EAN	8054247087968	8054247087975	8054247087982
COD. ART.	S5030F	S5031F	S5032F
IMB	10 PZ	10 PZ	10 PZ
MISURA	CM 40	CM 50	CM 60



BALCONIERA REGOLABILE p 22 x h 16 cm

EAN	8054247087944	8054247087821	8054247087951
COD. ART.	S5030	S5031	S5032
IMB	10 PZ	10 PZ	10 PZ
MISURA	CM 40	CM 50	CM 60



BALCONIERA TONDA h 25

EAN	8051513126451	8051513126468
COD. ART.	S1005/22	S1005/25
IMB	10 PZ	10 PZ
MISURA	DIAM 22	DIAM 25

BARBECUE CON GRIGLIA E PORTAGIRARROSTO



COD. ART.	EAN	DESCRIZIONE	IMB
SBARGC	8054247085490	BARBECUE CON GRIGLIA E PORTAGIRARROSTO	1

DETTAGLI	Barbecue adatto per uso legna o uso carbone Dotato di griglia in acciaio inox Completo di piastre porta-girarrosto
DETTAGLI PRODUZIONE	ISO9001:2015 prodotto in accordo allo standard UNE EN1860-1:2013+A1 Graticole in accordo allo standard REACH
MISURA	75x41xH78.5 CM
PZ PER PALLET	43 PEZZI
NOTE	Girarrosto non incluso

BARBECUE SUPERLUX



COD. ART.	EAN	DESCRIZIONE	IMB
SBARLUX	8050030090665	BARBECUE SUPERLUX	1

DETTAGLI	<p>Barbecue Superlux adatto per uso carbone/legno</p> <p>Griglia con manici posizionabile in 5 altezze in base al cibo</p> <p>Piccola leccarda raccogli liquidi di cottura Dotato di mattoni refrattari</p> <p>Piano di lavoro laterale</p> <p>Cassetto per deposito cenere e carbone per una facile pulizia</p> <p>Trasportabile in auto</p> <p>Struttura esterna coibentata per evitare le scottature Vano portavivande e vano portalegna</p>
DETTAGLI PRODUZIONE	<p>ISO9001:2015 prodotto in accordo allo standard UNE EN1860-1:2013+A1 Graticole in accordo allo standard REACH</p>
MISURA	110X47.5XH190 CM
PZ PER PALLET	6 PEZZI

CERAMICA DA ARROSTO

PORTA ARROSTICINI CUOIO

EAN 8050030090870

COD. ART. CCPA

IMB 4 pz

MISURA Ø cm 15x h 17



	PIATTO PIANO CUOIO	PIATTO FRUTTA CUOIO	PIATTO FONDO CUOIO
EAN	8050030090788	8050030090795	8050030090771
COD. ART.	CCPI25	CCPI15	CCPI20
IMB	6 pz	6 pz	6 pz
MISURA	Ø cm 27	Ø cm 22	Ø cm 24

CERAMICA DA ARROSTO



BICCHIERINO MIRTO CUOIO

EAN	8050030090696
COD. ART.	CCMI
IMB	12 pz
MISURA	∅ cm 4,5 x h 7



BICCHIERE CONO CUOIO

EAN	8050030090689
COD. ART.	CCBI
IMB	6
MISURA	∅ cm 8 (inf. 5cm) x h 9,5



	BROCCA 1,5 LT	BROCCA 1 LT	BROCCA 1/2 LT
EAN	8050030090702	8050030090719	8050030090726
COD. ART.	CCBRO1LT	CCBRO05LT	CCBRO025LT
IMB	4 pz	5 pz	12 pz
MISURA	∅ cm 18x h 20	∅ cm 16 x h 17	∅ cm 13 x h 16

CERAMICA DA ARROSTO



PORTA SALE CUOIO

EAN	8050030090818
COD. ART.	CCPS
IMB	6
MISURA	∅ vasc cm 5,5 x h 8



BICCHIERE CON MANICO CUOIO

EAN	8050030090849
COD. ART.	CCBM
IMB	6
MISURA	cm 15 x h 11



PIATTO PORTA ANTIPASTI CUOIO

EAN	8050030090801
COD. ART.	CCPI28
IMB	6
MISURA	cm 27 x 19

CERAMICA DA ARROSTO



	CIOTOLA 25 cm	CIOTOLA 18 cm	CIOTOLA 14 cm	CIOTOLA 8 cm
EAN	8050030090757	8050030090740	8050030090733	8050030090764
COD. ART.	CCCIO22	CCCIO18	CCCIOM	CCPI2
IMB	6 pz	6 pz	6 pz	12 pz
MISURA	∅ cm 25 x h 7	∅ cm 18 x h 6	∅ cm 14 x h 6	∅ cm 8 x h 6



	PORTASPAZZOLINI
EAN	8050030090825
COD. ART.	CCB
IMB	6 pz
MISURA	∅ cm 8x h 11

	POSACENERE QUADRATO
EAN	8050030090832
COD. ART.	CCPOCE
IMB	6 pz
MISURA	cm 17 x h 4

CERAMICA



SCIVEDDA

EAN	COD. ART.	MISURA	INNER
8051513122002	CSCI10	Ø cm 10 x h 5	20 pz
8051513122019	CSCI15	Ø cm 16 x h 6	7 pz
8051513122026	CSCI20	Ø cm 20 x h 7	5 pz
8051513122033	CSCI22	Ø cm 22 x h 8	4 pz
8051513122040	CSCI24	Ø cm 26 x h 9	5 pz
8051513122057	CSCI30	Ø cm 30 x h 10	4 pz
8051513122064	CSCI36	Ø cm 36 x h 12	4 pz
8051513122071	CSCI40	Ø cm 40 x h 14	3 pz



SALVADANAIO

EAN	COD. ART.	MISURA	INNER
8051513123948	CSALVA30	Ø cm 23 x h 30	4 pz
8051513123931	CSALVA25	Ø cm 20 x h 25	4 pz
8051513123924	CSALVA20	Ø cm 16 x h 20	6 pz
8051513123917	CSALVA16	Ø cm 13 x h 16	6 pz